

SOLAR PUMP WITH AUTO-SWITCHING CONTROLLER

Instruction book

A300-2500W

A200-1800W

A150-1500W

A110-1500W

A380-3000W

A380-4000W



(>2200W)



(≤2200W)



Contents

1.	Safety instruction.....	3
1.1	Ground connection	3
1.2	Power-on.....	3
2.	Power input specifications.....	3
2.1	Solar panel connection instructions and recommendations.....	3
2.2	Three-phase AC power Instructions and Notes.....	4
3.	Working environment and electrical characteristics.....	5
4.	Operation Panel	6
4.1	LED indicator light.....	6
5.	Pre-use inspection	7
6.	Pump operation mode	7
6.1	Pump start.....	7
6.2	Pump stop.....	8
6.3	Pump operation.....	9
6.4	Speed setting.....	10
7.	AC/DC switching strategy (two power supplies connected at the same time)	11
7.1	Independent solar power supply.....	11
7.2	Simultaneous AC and DC power supply	11
7.3	Solar DC power supply switching to Simultaneous AC and DC power supply conditions.....	11
7.4	Simultaneous AC and DC power supply switching to solar DC power supply conditions.....	11
7.5	AC power incoming monitoring.....	11
8.	Maintenance.....	12
9.	Fault information and troubleshooting methods	13

1. Safety instruction

When the controller is running, it is strictly forbidden to touch or unplug the power cord and output motor wire. Any operations involving touch and installation must be performed when the controller is completely powered off (that is, all input power is cut off).

1.1 Ground connection

When this product is powered by AC power supply, it must be connected to the earth wire of the AC power to prevent leakage of the product.

1.2 Power-on

The sequence of power-on is to turn on AC power first, then solar power.

2. Power input specifications

2.1 Solar panel connection instructions and recommendations

A. Solar panel selection.

Total solar panel power recommendation: (1.2-1.3) times the rated power of the pump.

Recommended optimal operating voltage for solar panels: (1.0-1.4) times the rated voltage of the pump.

B. Solar panel recommendations.

Controller model	Quantity of recommended solar panels
A110-1500W	4-6 pcs of 330W solar panels
A150-1500W	5-7 pcs of 330W solar panels
A200-1800W	6-8 pcs of 330W solar panels
A300-2500W	8-9 pcs of 330W solar panels
A380-3000W	12 pcs of 330W solar panels
A380-4000W	15 pcs of 330W solar panels

2.2 Three-phase AC power Instructions and Notes

A. For the controller AC380, The RST interface on the AC side needs to be connected to a three-phase AC power supply with an earth line E.

B. If the RST interface is not connected to three-phase AC power supply, for example, it is connected to two of the three phases, or connected to the neutral live line of AC220V/AC110V, the controller can also be powered on at this time, but the controller will not drive the motor, and report the input phase loss error. If you need to use the AC power input of this product, the AC interface needs to be connected to all the phase lines of the three-phase power supply. The other input methods cannot make the device drive the motor normally.

Water pump system wiring diagram

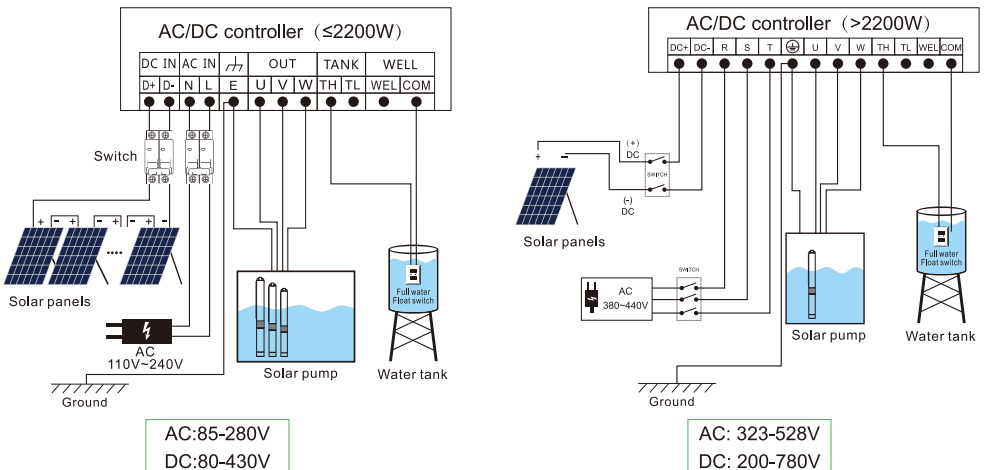

3. Working environment and electrical characteristics

Controller and Pump matching method							
Controller Model	Adaptable Pump	Rated Input Power (KW)	Max Input Current (A)	Max. Input Voltage (V)	Min. Input Voltage (V)	Optimal MPPT Voltage (V)	Working Environment (°C)
A110-1500W	Rated 110V Pump	1.5	10.0	DC420V/AC280V	DC80V/AC85V	110-400	-15-60
A150-1500W	Rated 150V Pump	1.5	10.0	DC420V/AC280V	DC80V/AC85V	150-400	-15-60
A200-1800W	Rated 200V Pump	1.8	10.0	DC420V/AC280V	DC80V/AC85V	200-400	-15-60
A300-2500W	Rated 300V Pump	2.5	10.0	DC420V/AC280V	DC80V/AC85V	300-400	-15-60
A380-3000W	Rated 500V pump	3.5	17.0	DC780V/AC528V	DC200V/AC323V	520-650	-15-60
A380-4000W	Rated 500V pump	4.5	17.0	DC780V/AC528V	DC200V/AC323V	520-650	-15-60







Attention:

Be sure to use an instrument to detect the open circuit voltage of the solar panel before powering on, or calculate the open circuit voltage of the solar panel according to the knowledge of series and parallel connection. The open circuit voltage of the solar panel must not exceed the maximum input voltage of the controller, otherwise it will cause irreversible damage.

4. Operation Panel

4.1 LED indicator light

- Voltage indicator light (V) : Light on in voltage display mode, otherwise off
- Speed indicator light (RPM) : Light on in speed display mode, otherwise off
- Current indicator light (A) : Light on in Current display mode, otherwise off
- Power indicator light (W) : Light on in power display mode, otherwise off
- Full water indicator light of tank (Tank) : Light on when the tank is full of water, otherwise off
- Water shortage Indicator light of well (Well) : Light on when the well is shortage of water, otherwise off
- Solar mode running indicator light (MPPT) : Light on when it is solar powered, otherwise off
- Power and running indicator light (Power) : Light flickers when the pump is stopped, it is always on when it is running in DC mode, and it flickers once every 5S when it is running in AC mode.

Key Type	Function
 Set Key	➤ Factory parameter setting, unopened.
 Enter	➤ Factory parameter setting, unopened.
 Up	➤ Running speed setting key, each time you press it, the speed will increase by one gear.
 Down	➤ Running speed setting key, each time you press it, the speed will decrease by one gear.
 Switch	➤ In the running status interface, switch the display mode. The display mode is cyclically switched between voltage (V) -> speed (RPM) -> current (A) -> power (W).
 On/Off	➤ In the running state, press the key to stop; And in the stop state, press the key to start.

5. Pre-use inspection

- 5.1 Before use, check whether the pump is intact, whether there is any looseness, seepage, or oil leakage at each connection, and whether there is any accidental damage such as bumps and scratches on the cables.
- 5.2 When the pump cable is not long enough and needs to be added, the joint of the added wire should be sealed with waterproof tape.
- 5.3 Before the pump is officially used, first connect it to the power source and check whether it starts and runs normally. The working direction of the pump is counterclockwise, please pay attention to make it run for a short time, and check whether the rotation of the pump is correct. It is strictly prohibited to run without water. If the rotation direction of the three-phase pump is wrong, adjust any two wires of the power input wires.
- 5.4 When installing and lifting the pump, use the ropes at the pore ring of pump outlet. It is strictly forbidden to pull the cable to lift or lower the pump. The pump should be installed more than 1 meter far from the bottom, to prevent mud and sand from being sucked in and damaging the mechanical seal and impeller etc.

6. Pump operation mode

6.1 Pump start

(1) Power on to start

Each time the power is turned on, when the float switch is not connected, the system starts by default (adjustable if need to memorize the factory mode). After connecting the float switch, it starts according to the float switch signal.

(2) Button to start

Press the run key  to start the water pump. After connecting the float switch, it starts according to the float switch signal.

(3) Water shortage of tank to start

When the system is turned on but the water pump is in the shutdown state, after the WELL and COM is disconnected, the TL signal terminal of the main control board is closed, and the water pump starts immediately. Without the TL closing signal, wait for 15 minutes.

(4) Full water of tank to start

When the system is turned on but the water pump is in the shutdown state, after TH and COM is disconnected, the TL signal terminal of the main control board is closed, and the water pump starts immediately. Without the TL closing signal, wait for 15 minutes.

6.2 Pump stop

(1) Float switch signal to stop

In pump running state, when the full water switch in the tank is closed (Tank light is on), the water pump stops immediately.

In pump running state, when the water shortage switch in the well is closed (Well light is on), the water pump stops immediately.

(2) Dry pumping shutdown

The water pump works continuously for a period of time. If the current power is less than the setting power at the current speed for 20s, it will stop immediately and report P48 fault. After 10 minutes, the fault is cleared.

(3) Button to stop



In pump running state, stop the pump by pressing .

6.3 Pump operation

Every time the water pump starts, it will recognize the power supply mode of DC (battery) and PV (solar). The recognition time is 20S, and then switch to the corresponding mode to run.

During the recognition process, the setting speed is invalid.

(1) DC mode (battery)

In DC (battery) mode, the speed of the water pump is adjustable, and the adjustable range is 1000-6000RPM. The default setting speed is 4000RPM, and the speed can be set by the  or  key. Each time you press the increment (or decrement) button, the setting speed will increase (or decrease) by one gear.

As the water pump runs, the DC (battery) power supply voltage will continue to drop. To prevent excessive discharge, the water pump stops working when the voltage is lower than the corresponding electrical protection voltage.

Model	Protection Voltage(V)
A110-1500W	80
A150-1500W	120
A200-1800W	140
A300-2500W	160
A380-3000W	200
A380-4000W	200

(2) PV mode:

In PV mode, the pump speed setting is similar to DC mode, and the maximum speed (4000RPM) limit is valid. The running speed of the pump is also determined by the current solar panel power. The system tracks the maximum power of the solar panel in real time (namely MPPT). When the sunlight enhances, the output power of the solar panel increases, then the running speed of the water pump increases, and vice versa.

In PV mode, the MPPT indicator flashes. The faster the flashing frequency, it means that the current work is closer to the maximum working point; if the flashing frequency is slower or it does not flash, it means that it is currently climbing to track the maximum power point.

If the solar power is insufficient, the running speed of the water pump will continue to drop. When the speed drops to 600rpm, the water pump will stop and report P46 fault. At the first 5 times, it will try to start every 10S, and the next, retry to start every 10minutes.

When the solar power is insufficient to maintain the starting or running of the current system, the output voltage of the solar panel will drop rapidly. When it drops to the lowest voltage of the system and lasts for 10S, reports a low power fault "PL" . At the first 5 times, it will try to start every 10S, and the next, retry to start every 10 minutes.

6.4 Speed setting

Power-on default startup speed (adjustable in factory mode), users can set the speed, but it will not be memorized after power-off (adjustable in factory mode if need to be memorized).

7. AC/DC switching strategy (two power supplies connected at the same time)

7.1 Independent solar power supply

When the solar light is strong, switch to solar power for independent power supply.

7.2 Simultaneous AC and DC power supply

When the solar light is weak, switch to Simultaneous AC and DC power supply.

7.3 Solar DC power supply switching to Simultaneous AC and DC power supply conditions

In DC powered working status, when it is detected that the working power is less than the cut-off value (60S of judging anti-shake time), switch to AC powered working.

7.4 Simultaneous AC and DC power supply switching to solar DC power supply conditions

- (1) In simultaneous AC and DC power supply status, when it is detected that the solar voltage is higher than the set voltage, and the switching waiting time expires, switch to solar powered working. When the sunlight is enhancing, the waiting time is 15 minutes, and when the sunlight is falling, the waiting time is 30 minutes.
- (2) In simultaneous AC and DC power supply status, when AC power is cut off, switch to solar DC powered working.

7.5 AC power incoming monitoring

When the solar working voltage cannot meet the independent power supply, and the AC power is in a power-off state, then the AC power is regularly monitored for incoming AC power, and it is switched to AC powered working after AC power is incoming. Wait for 5 minutes to monitor once, then wait for 15 minutes to monitor once, and then monitor every 30 minutes for incoming AC power. When the shutdown button is pressed, the AC power will be monitored immediately after the pump stops.

Model	Voltage of Simultaneous power supply switching to solar DC power (Switching when it is higher than this voltage)	Power of solar DC power switching to AC power (Switching when it is lower than this power)	Waiting time for switching to solar DC power When the sunlight is enhancing. (15 minutes by default)
A110-1500W	90V	250W	15
A150-1500W	110V	250W	15
A200-1800W	150V	250W	15
A300-2500W	200V	250W	15
A380-3000W	350V	750W	15
A380-4000W	400V	1000W	15

8. Maintenance

- 8.1 After the pump has been running for 3000 hours, suggest checking the wearing parts (such as bearings, seals, mechanical seals etc.), otherwise the damage of the mechanical parts will cause greater losses.
- 8.2 If the pump is not used for a long time, it should be cleaned and dried, and properly kept in a ventilated and dry place.

9. Fault information and troubleshooting methods

Fault type			
Fault code	Fault description	➤ Causes and solutions of fault.	Recovery procedure
P0	Hardware overcurrent	<ul style="list-style-type: none"> ➤ Motor model is mismatched, please choose matching pumps. ➤ UVW three-phase short-circuit connection, please rewiring to ensure the normal installation of UVW. 	Automatically cleared after 30s, try 5 times
P43	Output phase loss protection	➤ UVW three-phase open circuit, please rewire to ensure it reliable contact.	Automatically cleared after 30s at the first 5 times, then try to start again after 30 minutes
P44	Boot failure	➤ Check whether the motor wire is connected well and whether it is stuck.	
P46	Stall protection	<ul style="list-style-type: none"> ➤ Motor model is mismatched, please choose matching pumps. ➤ Pump extension cord is too long, please reduce the extension cord. ➤ Power is too low, please increase the power supply. ➤ Pump bearing is stuck, please clean pump bearings. 	Automatically cleared after 30s at the first 5 times, then try to start again after 10 minutes
P51	High voltage protection	➤ The input voltage is too high, please distribute power refer to the electrical characteristics.	After voltage returns to normal, cleared the fault immediately

P48	Dry-run protection	<ul style="list-style-type: none"> ➢ Not all of air in the pump is exhausted, cut off the power, re-power and start the pump drainage after 30 seconds. ➢ There is no water in the water tank waiting for water, it will restart. 	Automatically cleared after 10s at the first 3 times, then try to start again after 10 minutes
P60	High temperature protection	<ul style="list-style-type: none"> ➢ The temperature of controller MCU is more than 90°C. 	Automatically cleared after the temperature is normal
PL	Low voltage protection/Power shortage	<ul style="list-style-type: none"> ➢ The voltage input is too low, please refer to the electrical characteristics of the corresponding model for normal power distribution. ➢ Solar panel matching error, refer to the recommendation to match correctly. 	First 5 times, clear after 30 seconds; And the next, cleared after 30 minutes
P42 (A380 only)	Input phase loss protection	There is an open circuit in the RST input of the three-phase power supply,ensure that after the power is cut off,reconnect the wiring to ensure reliable contact.	Automatically cleared after fault recovery
P45/ P47 (A380 only)	Out-of-step protection/Over-speed protection	<ul style="list-style-type: none"> ➢ Motor model is mismatched,please choose a matching pump. ➢ Pump extension cord is too long,please reduce the extension cord. ➢ Pump bearing is stuck,please clean pump bearings. 	Automatically cleared after 30s at the first 5times,then try to start again after 30 minutes
P59 (A380 only)	Abnormal power supply mode selection	<ul style="list-style-type: none"> ➢ When the controller selects the power supply mode set by P0.2,the corresponding power input cannot be detected,then the fault code will be reported,Please confirm whether the power supply mode selection matches with the controller wiring. 	Automatically cleared after fault recovery